



DANTE SERIES COUNTERTOP CHARBROILERS SERIES: CLASSIC XX



Bakers Pride® XX series charbroilers are designed for heavy-duty broiling in a low-profile, countertop design. Models come in a range of widths (from 26" to 53") with four to ten burners. The charbroilers in this series feature durable stainless steel construction and an output of 18,000 BTUH per burner for high yet energy-efficient performance.

This series also comes standard with cast-iron top grates, stainless steel radiants, and aluminized steel burners. Grates may be adjusted in three separate titling positions for increased flexibility and temperature control. The interior combustion chamber is fully welded from hot-rolled steel for extra durability.

This series also offers many options to suit your needs, such as Glo-Stones for enhanced flavor and work decks for added convenience.

FEATURES AT A GLANCE

- 13.25" (337 mm) tall
- Aluminized steel burners every 4.87" (124 mm)
- 18,000 BTUH per burner
- Individually operated control valves
- Natural gas or liquid propane
- Cast-iron grates (standard) or floating rod, fish, or meat grates
- Grates are 24" (610 mm) long with 3/4" (19 mm) rib spacing
- Adjustable grates with three titling positions
- Stainless steel radiants
- All stainless steel exterior, slide-out grease drawer, and 4" (102 mm) legs
- 3/4" (19 mm) NPT rear gas connection
- Pressure regulator
- One-year limited warranty

OPTIONS & ACCESSORIES

- Glo-Stones (field-convertible)
- Cast-iron radiants
- Stainless steel, front-mounted work deck (with or without saucepan cut-outs)
- Richlite front-mounted work deck (with or without saucepan cut-outs)
- Condiment rail
- Flame failure safety pilots and CE approval (see XXE models)
- Stainless steel equipment stand (with or without casters)
- Gas connector hose
- Stainless steel splash guard
- Removable griddle plates
- Overhead back shelves
- Grate lifters



DANTE SERIES COUNTERTOP CHARBROILERS

SERIES: CLASSIC XX

EQUIPMENT DIMENSIONS

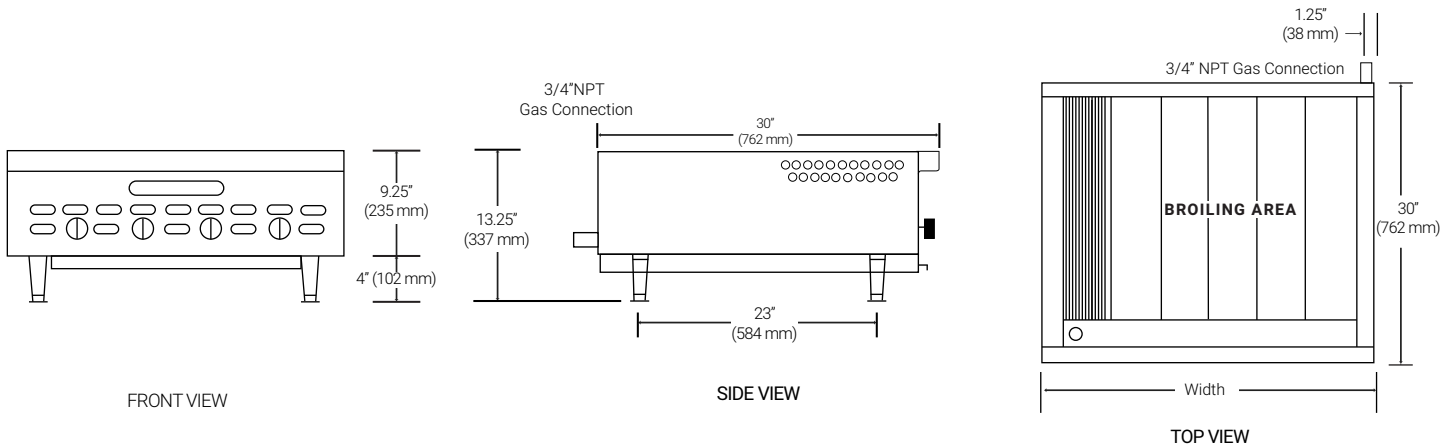

MECHANICAL SPECIFICATIONS

Model #	BTU	KW	# Grates	# Burners	Broiling Area	Overall Dim (W x H x D)*	Carton Dim (W x H x D)	Cubic Feet	Cubic Feet	Ship Wt.
XX-4	72,000	21.09	4	4	21" x 24" (533 x 610)	26.25" x 13.25" x 30" (667 x 337 x 762)	33" x 35" x 33.5" (838 x 889 x 851)	23.7	.7	330 (150kg)
XX-6	108,000	31.64	6	6	31.5" x 24" (800 x 610)	36.75" x 13.25" x 30" (933 x 337 x 762)	52.5" x 37" x 39.5" (1335 x 940 x 1003)	23.7	.7	355 (161kg)
XX-8	144,000	42.19	8	8	42" x 24" (1067 x 610)	47.75" x 13.25" x 30" (1213 x 337 x 762)	52.5" x 37" x 39.5" (1335 x 940 x 1003)	44.4	1.2	435 (198kg)
XX-10	180,000	52.74	10	10	52.5" x 24" (1334 x 610)	58.25" x 13.25" x 30" (1480 x 337 x 762)	69" x 35" x 28" (1753 x 889 x 711)	44.4	1.2	585 (265kg)

*Height includes 4" (102 mm) legs.

REQUIRED CLEARANCES

	Combustible
Left	0" (0 mm)
Right	0" (0 mm)
Back	0" (0 mm)

GAS CONNECTIONS

Natural or LP gas
 3/4" NPT rear gas connection

Bakers Pride reserves the right to modify specifications or discontinue models without incurring obligation. Dimensions nominal.



Freight Class: 70
 FOB: 75013

4.8.2019

